

Installation Guide for Hardwood Flooring

**Commercial Hardwood Installation Instructions**

*Deeply Rooted™ (9/16"), Nurtured™ (1/2"), Wooded Habitat™ (3/8")*

*Engineered Products – For staple down, mechanically fastened, floating and glue-down applications.*

*THANK YOU FOR CHOOSING PARTERRE FLOORING PRODUCTS. If properly installed and cared for, your new flooring will be easy to maintain and will look great for years to come. If you have questions or comments, visit us at [parterreflooring.com](http://parterreflooring.com) or 1-866-243-2726.*

*These directions are based on industry standards and best practices. Failure to follow these installation instructions may result in damage to the flooring and void the floor's warranty.*

- *For complete warranty information, call 1-866-243-2726 or go to [parterreflooring.com](http://parterreflooring.com).*
- *For technical or installation questions, or to request a Safety Data Sheet, call 1-866-243-2726 or visit [hardwoodexpert.com](http://hardwoodexpert.com) our technical website.*
- *For general questions or comments, visit us at [ahfproducts.com](http://ahfproducts.com) or call 1-866-243-2726.*

*Recommended Installation Products*

Adhesives	Bruce ProConnect™ Plus Bruce Equalizer Pro™ Bruce Summit Select™
Adhesive Remover	Low Odor Mineral Spirits
Cleaner	Bruce® Hardwood & Laminate Floor Cleaner
Underlayment (floating installation system only)	Premium Underlayment
Wood Glue (floating installation & joint gluing)	Bruce EverSeal™ Adhesive

**NOTE:** Do not staple down traditionally finished Pecan, Maple, or Hickory products. All species of textured products (such as scraped, wire-brushed, and rustic/distressed products) can be stapled down with 20-gauge staples (1" minimum length for 3/8" – 1/2" engineered hardwood, for 9/16" hardwood use 1-1/4" fasteners). Birch, Hickory, Maple, and Pecan hand-scraped products can be stapled down using the recommended fastening machines.

**For Products wider than 5"**

In addition to the use of mechanical fasteners, assisted glue applications should be used. The glue should be a premium grade urethane construction adhesive applied in a serpentine pattern to the back of each board. Then follow the recommended fastening pattern.



---

Installation Guide for Hardwood Flooring

## GENERAL INFORMATION

### Owner/Installer Responsibility

Beautiful hardwood floors are a product of nature and therefore, not perfect. Our hardwood floors are manufactured in accordance with accepted industry standards. For optimum performing hardwood flooring, carefully read and follow these installation instructions.

- These hardwood floors were manufactured in accordance with accepted industry standards, which permit grading deficiencies not to exceed 5%. These grading deficiencies may be of a manufacturing or natural type. When flooring is ordered, 5% must be added to the actual square footage needed for cutting and grading allowance (10% for diagonal installations).
- The owner/installer has final inspection responsibility as to grade, manufacture and factory finish. Inspection of all flooring should be done prior to installation. The flooring should also be carefully examined for color, finish, and quality before installing it.
- The installer must use reasonable selectivity and not use or cut off pieces with deficiencies, whatever the cause. Should an individual piece be doubtful as to grade, manufacture or factory finish, the installer should not use that piece. If material is not acceptable, do not install it and contact the seller immediately.
- Prior to installation of any hardwood flooring product, the owner/installer must determine that the job-site environment and the sub-surfaces involved meet or exceed all applicable standards. Recommendations of the construction and materials industries, as well as local codes, should be followed. These instructions recommend that the construction and subfloor be clean, dry, stiff, structurally sound, and flat. The manufacturer declines any responsibility for job failure resulting from, or associated with, subfloor and substrates or job-site environmental deficiencies.
- Use of stain, filler or putty stick for touch-up and appropriate products for correcting subfloor voids is accepted as part of normal installation procedures.

### **ATTENTION INSTALLERS**

#### **! CAUTION: WOOD DUST**

Sawing, sanding, and machining wood products can produce wood dust. Airborne wood dust can cause respiratory, eye and skin irritation. The International Agency for Research on Cancer (IARC) has classified wood dust as a nasal carcinogen in humans.

**PRECAUTIONARY MEASURES:** If power tools are used, they should be equipped with a dust collector. If high dust levels are encountered, use an appropriate NIOSH-designated dust mask. Avoid dust contact with eye and skin.

**FIRST AID MEASURES IN CASE OF IRRITATION:** In case of irritation, flush eyes, or skin with water for at least 15 minutes.

## Installation Guide for Hardwood Flooring

If you have any technical or installation questions, or to request a Safety Data Sheet, call 1-866-243-2726 or visit [hardwoodexpert.ahfproducts.com](http://hardwoodexpert.ahfproducts.com).

### **IMPORTANT HEALTH NOTICE FOR MINNESOTA RESIDENTS ONLY:**

THESE BUILDING MATERIALS EMIT FORMALDEHYDE. EYE, NOSE, AND THROAT IRRITATION, HEADACHE, NAUSEA AND A VARIETY OF ASTHMA-LIKE SYMPTOMS, INCLUDING SHORTNESS OF BREATH, HAVE BEEN REPORTED AS A RESULT OF FORMALDEHYDE EXPOSURE. ELDERLY PERSONS AND YOUNG CHILDREN, AS WELL AS ANYONE WITH A HISTORY OF ASTHMA, ALLERGIES, OR LUNG PROBLEMS, MAY BE AT GREATER RISK. RESEARCH IS CONTINUING ON THE POSSIBLE LONG-TERM EFFECTS OF EXPOSURE TO FORMALDEHYDE.

REDUCED VENTILATION MAY ALLOW FORMALDEHYDE AND OTHER CONTAMINANTS TO ACCUMULATE IN THE INDOOR AIR. HIGH INDOOR TEMPERATURES AND HUMIDITY RAISE FORMALDEHYDE LEVELS. WHEN A HOME IS LOCATED IN AREAS SUBJECT TO EXTREME SUMMER TEMPERATURES, AN AIR-CONDITIONING SYSTEM CAN BE USED TO CONTROL INDOOR TEMPERATURE LEVELS. OTHER MEANS OF CONTROLLED MECHANICAL VENTILATION CAN BE USED TO REDUCE LEVELS OF FORMALDEHYDE AND OTHER INDOOR AIR CONTAMINANTS.

IF YOU HAVE ANY QUESTIONS REGARDING THE HEALTH EFFECTS OF FORMALDEHYDE, CONSULT YOUR DOCTOR OR LOCAL HEALTH DEPARTMENT.

## **PREPARATION**

### **Storage and Handling**

Handle and unload with care. Store in a dry place being sure to provide at least a four-inch air space under cartons which are stored upon “on-grade” concrete floors. Flooring should not be delivered until the building has been enclosed with windows and doors are in place, and cement work, plastering and all other “wet” work is completed and dry.

Although it is not necessary to acclimate engineered flooring it is best to store it in the environment in which it is expected to perform prior to installation. Check adhesive label for adhesive storage limitations.

### **Job-Site Conditions**

- The building should be enclosed with all outside doors and windows in place. All concrete, masonry, framing members, drywall, paint, and other “wet” work should be thoroughly dry. The wall coverings should be in place and the painting completed, except for the final coat on the base molding. When possible, delay installation of base molding until flooring installation is complete. Basements and crawl spaces must be dry and well ventilated.

## Installation Guide for Hardwood Flooring

- Exterior grading should be complete with surface drainage, offering a minimum drop of 3" in 10' (7.6 cm in 3.05 m) to direct flow of water away from the structure. All gutters and downspouts should be in place.
- Engineered flooring may be installed below-, on- or above-grade level. Do not install in full bathrooms.
- Crawl spaces must be a minimum of 18" (46 cm) from the ground to the underside of the joists. A ground cover of 6-20 mil black polyethylene film is essential as a vapor barrier with joints lapped 6" (15 cm) and sealed with moisture resistant tape. The crawl space should have perimeter venting equal to a minimum of 1.5% of the crawl space square footage. These vents should be properly located to foster cross ventilation (Figure 1).

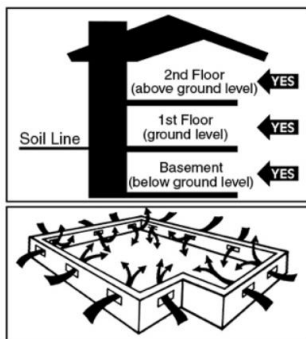

Figure 1

- Where necessary, local regulations prevail.
- The installation site should have a consistent room temperature of 60-80°F (16-27°C) and humidity of 30%-50% for 14 days prior to and during installation and until occupied.

**WARNING: REGARDING EXISTING IN-PLACE RESILIENT FLOOR COVERING AND ASPHALTIC ADHESIVES. DO NOT SAND, DRY SWEEP, DRY SCRAPE, DRILL, SAW, BEADBLAST, OR MECHANICALLY CHIP OR PULVERIZE EXISTING RESILIENT FLOORING, BACKING, LINING FELT, ASPHALTIC "CUTBACK" ADHESIVE, OR OTHER ADHESIVE.**

These existing in-place products may contain asbestos fibers and/or crystalline silica. Avoid creating dust. Inhalation of such dust is a cancer and respiratory tract hazard. Smoking by individuals exposed to asbestos fibers greatly increases the risk of serious bodily harm.

Unless positively certain that the existing in-place product is a non-asbestos-containing material, you must presume it contains asbestos. Regulations may require that the material be tested to determine asbestos content and may govern removal and disposal of material.

---

## Installation Guide for Hardwood Flooring

See current edition of the Resilient Floor Covering Institute (RFCI) publication *Recommended Work Practices for Removal of Resilient Floor Coverings* for instructions on removing all resilient floor covering structures or contact your retailer or AHF Products at 1-866-243-2726.

AHF Products' floor coverings and adhesives do NOT contain asbestos.

### Subfloor Conditions

- **Clean** – subfloor must be free of wax, paint, oil, sealers, adhesives, and other debris.
- **Level/Flat** – subfloor must be within 3/16" in 10' (5 mm in 3 m) and/or 1/8" in 6' (3 mm in 2 m). Sand high areas or joints. If the floor is to be glued down, fill low areas with a latex additive cementitious leveling compound of 3,000-PSI minimum compressive strength patch and underlayment. Follow the instructions of the leveling compound manufacturer but make certain the leveling compounds are completely DRY before beginning installation. When mechanically fastening the floor down, flatten low spots with a maximum of 6 layers of 15# builders felt, plywood or shims (not leveling compounds). Leveling materials must provide a structurally sound subfloor that does not affect the holding power of the fastener.
- **Dry** – check and document moisture content of the subfloor using the appropriate moisture test. Concrete subfloors must be a minimum of 30 days old before testing begins.
- **Structurally Sound** – any areas that are loose or squeak, must be nailed or screwed. Wood panels should exhibit an adequate fastening pattern, glued/screwed, or nailed as system requires, using an acceptable nailing pattern. Typical: 6" (15 cm) along bearing edges and 12" (31 cm) along intermediate supports. Flatten edge swell as necessary. Replace any water-damaged, swollen, or delaminated subflooring or underlayments.

Subfloors with excessive vertical movement should be avoided. Optimum performance of hardwood floor covering products occurs when there is little horizontal or vertical movement of the subfloor. If the subfloor has excessive vertical movement (deflection) before installation of the flooring, it is likely it will do so after installation of the flooring is complete.

### Subfloors with Radiant Heat

**NOTE:** Always make certain the product selected is recommended for this type of application. System must be operational and heated for at least 7 days prior to beginning the installation.

- Use an incremental control strategy that brings the floor through temperature changes gradually which may include an external thermostat.
- Turn off heat and let subfloor cool down to room temperature 3-4 hours prior to starting the job.
- BEFORE installation begins, ascertain that the heating system is designed and controlled for wood flooring and that the circuit does not include other floor covering types. Failure to do so may cause excessive heat damage and shrinkage.

## Installation Guide for Hardwood Flooring

**NOTE:** Refer to radiant heat system manufacturer's precautions for staple down installation. Beware of stapling through radiant tubing or mesh.

- After installation, turn the heating system back on immediately. The finished floor surface must not exceed 85°F (29°C) throughout the life of the floor.
- Radiant heating systems normally create dry heat that can lower interior humidity levels. It may be necessary to add humidity with humidifiers to maintain the recommended levels (30-50%) and prevent damage to the wood floor.
- The flooring should be end-glued over radiant heat to reduce longitudinal shrinkage. Apply a bead of the recommended wood glue to the groove end then insert the tongue. Wipe excess adhesive away immediately.

### Tools & Accessories Needed - (All Installation Methods)

- Broom
- Tape measure
- Hammer
- Chalk line & chalk
- Hand saw or jamb saw
- Recommended hardwood flooring cleaner
- Electric power saw
- Eye protection
- Recommended wood glue
- Moisture Meter (wood, concrete, or both)
- Transition and wall moldings
- NIOSH-designated dust mask



Figure 2

### (Add for Glue-Down Installations)

- Recommended adhesive and adhesive remover
- Recommended trowel
- Scotch® Delicate Surface Painter's Tape 2080
- Recommended wood glue for floors exceeding 3-1/4" (9.5 cm) in width

---

## Installation Guide for Hardwood Flooring

### **(Add for Mechanically Fastened/Staple-Down Installations)**

- Hardwood flooring stapler for engineered hardwood\*
- 1" staples/fasteners (minimum) for 3/8" – 1/2" products, for 9/16" products, 1-1/4" fastener
- 20-gauge fasteners
- Compressor and hose
- Nylon/Plastic tapping block
- In-line regulator
- Recommended wood glue for floors exceeding 3-1/4" (9.5 cm) in width

\* The Flooring Manufacturer does not recommend or endorse any specific brand or type of mechanical fastener.

### **(Add for Floating Installations)**

- Premium underlayment for floating hardwood flooring
- Pull bar
- Tapping block
- Recommended wood glue

## **SUBFLOOR/UNDERLAYMENT REQUIREMENTS**

### **Recommended Subfloor/Underlayment Surfaces (Glue Down and Floating Installations Only)**

- Concrete
- Ceramic Tile, Terrazzo, Slate & Marble
- Acoustic cork

### **(All Installation Methods)**

- Wood subfloors
- Wood structural panels and underlayment
- Fully adhered existing wood floors
- Fully adhered non-cushion vinyl sheet, resilient tile, cork flooring and linoleum

## **Concrete**

### **(Glue-Down and Floating Installations Only)**

The flooring can be glued directly to concrete with a minimum compressive strength of 3000 PSI. Do not install over a concrete sealer or painted concrete. If present, sealer, or paint must be removed by grinding or sanding. Do not install over slick, heavily troweled or burnished concrete. The surface must be roughened as necessary by sanding or grinding. Use an appropriate NIOSH-designated dust mask. Floating floors can be installed over any structurally sound concrete.



## Installation Guide for Hardwood Flooring

### Concrete Moisture Tests

All concrete subfloors should be tested, and results documented, for moisture content. Visual checks may not be reliable. Test several areas, especially near exterior walls and walls containing plumbing. Acceptable test methods for subfloor moisture content include:

- Tramex Concrete Moisture Encounter Meter (Figure 3): Moisture readings should not exceed 4.5 on the upper scale. (Figure 3 shows an unacceptable reading of over 4.5.) Concrete Moisture Meters give qualitative reading results-not quantitative ones. These results are a quick way to determine if further testing is required.

#### Concrete Moisture Tests

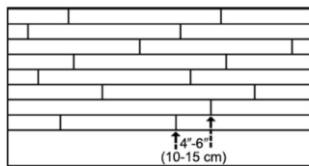

Figure 3  
Preferred Alignment

**NOTE:** The following tests are required in residential/commercial applications. Either or both tests are acceptable. If both tests are conducted, then both tests must pass.

- Calcium Chloride Test (ASTM F1869): The maximum moisture transfer must not exceed 3 lbs./1000 ft.<sup>2</sup> in 24 hours with this test.
- RH Levels in Concrete Using In-situ Probes (ASTM F2170) must not exceed 75%.

“DRY” CONCRETE, AS DEFINED BY THESE TESTS CAN BE WET AT OTHER TIMES OF THE YEAR. THESE TESTS DO NOT GUARANTEE A DRY SLAB.

### Moisture Retardant Systems

If excessive moisture is present or anticipated, use a moisture retardant system, Bruce Summit™ adhesive or inexpensive sheet vinyl must be used to reduce vapor intrusion.

- Sheet vinyl: Sheet vinyl or “slip-sheet” (felt-backed with vinyl wear layer) must be installed. Use a premium grade, alkali resistant adhesive and a full spread application system to properly bond the vinyl to the subfloor. Follow the sheet vinyl manufacturer’s instructions for installation procedures. A bond test may be required as an adhesion test. Install several small areas (3’ x 3’) (1 m x 1 m) and allow the vinyl to set for 72 hours. Remove the vinyl. If the backing remains attached to the concrete, the subfloor should be acceptable for sheet vinyl installation. Install the sheet vinyl and allow the adhesive to cure for 24 hours prior to beginning installation. Degloss as necessary to create an adequate adhesive bond. Always check for adequate adhesive bond.



---

## Installation Guide for Hardwood Flooring

### **Acoustic Concrete (Glue-Down or Floating Installations Only)**

Acoustic concrete normally contains large quantities of gypsum that may inhibit the adhesive's capability to properly bond. Acoustic concrete must be primed with the concrete manufacturer's recommended primer/surface hardener. Test the concrete by scraping the surface with a nail or other sharp object. If the concrete powders or crumbles, it is not sound and hardwood flooring should not be glued directly to the subfloor system. Always check for adequate adhesive bond. The concrete must have a minimum compressive strength of 2000 PSI.

### **Ceramic, Terrazzo, Slate & Marble (Glue-Down or Floating Installations Only)**

All grout joints and broken corners that exceed 3/16" (5 mm) must be filled with a cementitious leveling compound patch and underlayment. The surface must be cleaned and abraded to create a good bonding surface for the adhesive. Loose tiles must be re-adhered to the subfloor or filled as above. Remove all sealers and surface treatments must be removed. Always check for adequate adhesive bond.

### **Acoustic Cork Underlayment (Glue-Down or Floating Installations Only)**

The flooring must be glued or floated directly over full spread, permanently bonded acoustic cork. The cork must have a density of no less than 11.4 lb./cubic foot. The cork, in general, should be pure cork combined with a polyurethane or resin binder. Install cork in accordance with cork manufacturer's recommendations. Always check for adequate adhesive bond. When floating floors over cork DO NOT use foam underlayment.

### **Wood Subfloors and Underlayment (All Installation Methods)**

**General:** The wood subflooring materials must not exceed 12% moisture content. Using a reliable wood moisture meter, measure moisture content of both the subfloor and the hardwood flooring to determine proper moisture content. The wood subfloor should be checked at various locations throughout the installation approximately 20 readings or more should be taken and documented. The difference between the moisture content of the wood subfloor and the hardwood flooring must not exceed 3%. When installing parallel to the floor joists, it may be necessary to stiffen the subfloor system by installing an additional minimum of 3/8" (9.5 mm) approved underlayment. Applicable standards and recommendations of the construction and materials industries must be met or exceeded.

---

## Installation Guide for Hardwood Flooring

**NOTE:** As a flooring manufacturer, we are unable to evaluate each engineered system. Spacing and spans, as well as their engineering methods, are the responsibility of the builder, engineer, architect, or consumer who is better able to evaluate the expected result based on site-related conditions and performance. The general information provided below describes common, non-engineered joist/subfloor systems. Engineered flooring systems may allow for wider joist spacing and thinner subflooring materials. When wider joist spacing of 19.2" or greater is used at least one of the following options must be used:

### Option 1

When wider joist spacing of 19.2" or greater is used, additional plywood subfloor material must be added to reduce movement and deflection.

### Option 2

In addition to the use of mechanical fasteners, assisted glue applications must be used. The glue should be a premium grade urethane construction adhesive applied in a serpentine pattern to the back of each board. Then follow the recommended fastening pattern.

### Option 3

With wider spacing of 19.2", apply a bead of Bruce® EverSeal or similar product to the bottom of the end and side groove. This will lock the tongue and groove together eliminating movement that may contribute to noise. Then follow the recommended fastening pattern with a staple or cleat.

**NOTE:** Following one of these options is also intended to reduce noise associated with a mechanically fastened installation.

## Wood Structural Panel Subfloors and Underlayment (All Installation Methods)

Structural panels/underlayment must be installed sealed side down. When used as a subfloor, a 1/8" (3 mm) expansion space must be allowed between each panel. If spacing is inadequate, cut in with a circular saw. Do not cut in expansion space on tongue and groove panels.

- Plywood: Must be minimum CDX grade (exposure 1) and meet US Voluntary Product Standard PS1 performance standard or Canadian performance standard CAN/CSA 0325-0-92. The preferred thickness is 3/4" (19 mm) as a subfloor [minimum 5/8" (16 mm)] or 3/8" (9.5 mm) as underlayment
- Oriented Strand Board (OSB): Conforming to US Voluntary Product Standard PS2 or Canadian performance standard CAN/CSA 0325-0-92 construction sheathing. Check underside of panel for codes. When used as a subfloor, the panels must be tongue and groove and installed sealed side down. Minimum thickness to be 23/32" (18 mm) thick when used as a subfloor or 3/8" (9.5 mm) as underlayment.



## Installation Guide for Hardwood Flooring

- Waferboard and Chipboard: Conforming to US Voluntary Product Standard PS2 or Canadian performance standard CAN/CSA 0325-0-92. Must be 3/4" (19 mm) thick when used as a subfloor and 3/8" (9.5 mm) thick when used as an underlayment.
- Particleboard: Must be a minimum 40-lb. density, stamped underlayment grade and 3/4" (19 mm) thick.

### **Solid Wood Subfloors (All Installation Methods)**

- Minimum 3/4" (19 mm) thick with a maximum width of 6" (15 cm) installed at a 45° angle to the floor joists.
- The subfloor must be Group 1 dense softwood (Pine, Larch, Douglas Fir, etc.) No. 2 common, kiln dried with all board ends bearing on joists.
- For glue down applications, a 3/8" (9.5 mm) approved underlayment must be added.

### **Existing Wood Flooring (All Installation Methods)**

- Existing engineered flooring must be well bonded/fastened. When gluing over existing wood flooring of any thickness, the finishing materials must be abraded or removed to foster an adequate adhesive bond. When flooring is to be mechanically fastened, the existing engineered wood flooring must be a minimum of 3/8" (9.5 mm) thick installed over approved wood/wood composite underlayment that has been properly fastened. When installing over engineered flooring that is glued to concrete, the minimum thickness of that flooring must be 1/2" (13 mm) to allow for the length of the fastener.
- Existing solid wood flooring that exceeds 6" (15 mm) in width must be covered with 3/8" (9.5 mm) approved underlayment and fastened as required. Do not install over solid flooring attached directly to the concrete.

### **Vinyl, Resilient Tile, Cork Flooring and Linoleum (All Installation Methods – see notes below) (Glue-Down Installations)**

- Make certain the floor covering materials are well bonded to the subfloor/underlayment with full spread adhesive and are no more than two layers thick, not to exceed 3/16" (5 mm).
- With approved wood/wood composite subfloors, if vinyl or tiles are loose, broken, or in poor condition, install a 3/8" (9.5 mm) approved underlayment directly over the flooring materials.
- Clean the flooring materials as necessary to create a good adhesive bond. If a maintenance material is present on the floor covering or a gloss is present, de-gloss with a flooring pad and a commercially available stripper, then rinse completely. Allow ample drying time.

**NOTE:** Do not sand any resilient products. They may contain asbestos fibers, which may be harmful.

---

## Installation Guide for Hardwood Flooring

- Cork floors must have all sealers and surface treatments removed before installation begins. Always check for adequate adhesive bond.

### (Mechanically Fastened/Staple-Down Installations)

- Do not install over floors that exceed one layer, as the thickness of the flooring materials will prevent an adequate mechanical bond.
- Make certain that the subflooring materials meet minimum requirements. (See previous sections).
- Some tile products may be too brittle for staple penetration. Always test an area for breakage before proceeding.

## INSTALLING THE FLOOR

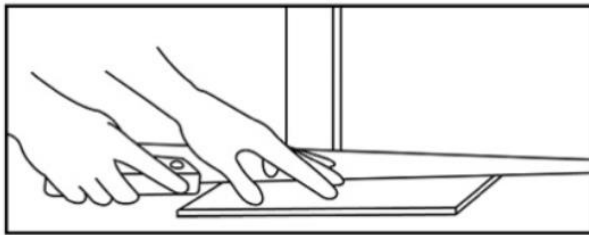

Figure 4

### General Installation Tips

**NOTE:** When installing UNFINISHED engineered flooring, allow a minimum of 72 hours adhesive curing time before applying seals, stains and finishes to unfinished flooring. Test the moisture content of the wood in accordance with the stain/finish manufacturer's recommendations.

- All species of textured products (such as scraped, wire-brushed, and rustic/distressed products) may be stapled or mechanically fastened, but products over 5" (12.7 cm) will require a serpentine bead of premium construction adhesive applied to the back of the plank.
- Floor should be installed from several cartons at the same time to ensure good color and shade mixture.
- When possible, preselect and set aside boards that blend best with all horizontally mounted moldings used to assure a uniform final appearance. Install these boards adjoining the moldings.
- Be attentive to staggering the ends of the boards at least 4"-6" (10-15 cm) when possible, in adjacent rows (Figure 4). This method will help ensure a more favorable overall appearance of the floor.

## Installation Guide for Hardwood Flooring

- When installing engineered products of uniform length, begin the rows with starter boards cut to various lengths. Avoid staggering the rows uniformly to prevent stair-stepping. Boards cut from the opposite end of the row may be used as the starter boards for the next row(s).
- Always allow a minimum 1/4" (6 mm) expansion around all vertical obstructions. Allow 1/2" (13 mm) for floating floors.

**NOTE:** For Glue-Down Installation: When installing products wider than 3-1/4" (8 cm), apply a bead of recommended wood glue to all the end grooves prior to installing into the adhesive.

For Staple-Down Installation: When installing products wider than 3-1/4" (8 cm) but not to exceed 5" (13 cm), apply a bead of recommended wood glue to all the end grooves prior to stapling down.

### STEP 1: Doorway and Wall Preparation (All Installation Methods)

Undercut door casings and jambs. Remove any existing base, shoe molding or doorway thresholds. These items can be replaced after installation. All door casings and jambs should be undercut to avoid difficult scribe cuts (Figure 5).

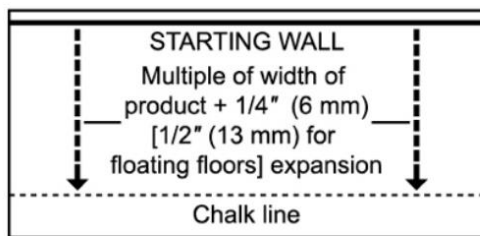

Figure 5

### STEP 2: Establish a Starting Point (All Installation Methods)

- Installation parallel to the longest wall is recommended for best visual effects; however, the floor should be installed perpendicular to the flooring joists unless the subfloor has been reinforced to reduce subfloor sagging.
- When possible, begin the layout or installation from the straightest wall, generally an outside wall.
- In at least two places, at least 18" (46 cm) from the corner, measure out equal distance from the starting wall (Figure 6) and snap a chalk line. The measurement must be the sum of the width of the flooring plus an additional 3/8" (9.5 mm) to allow for 1/4" (6 mm) expansion space and the width of the tongue. Allow 1/2" (13 mm) expansion when installing floating floors.

## Installation Guide for Hardwood Flooring

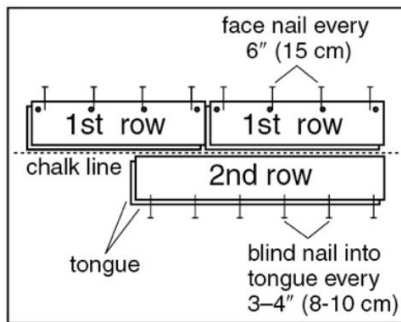

Figure 6

### STEP 3: Installing First & Second Rows (Mechanically Fastened/Staple-Down Installations)

- Use the longest, straightest boards available for the first two rows. For random and alternating width products, use the widest plank for the first row. Align tongue of first row on chalk line. The groove should be facing the starting wall. Pre-drill 1/2" (13 mm) from back (groove) edge, 1"-2" (2.5-5 cm) from each end, and at 6" (15 cm) intervals when possible (Figure 7). Fasten using 4 or 6d finishing nails or 1" (2.5 cm) pneumatic finish nails/brads. Countersink the nails.

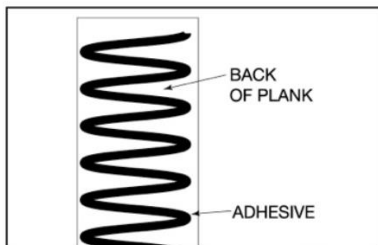

Figure 7

1st row - chalk line  
 2nd row - tongue  
 face nail every 6" (15 cm)  
 blind nail into tongue every 3"-4" (8 -10 cm)

- Pre-drill and blind-nail at a 45° angle through the tongue of the first row every 1"-2" (2.5-5 cm) from the ends and spaced in 3"-4" (7.6-10 cm) intervals. Countersink nails to ensure flush engagement of groove with the following row(s). Continue blind nailing using this method with following rows until stapler can be used. Alternatively use a pneumatic finish nailer and install nails/brads at the same intervals with a minimum length of 1" (2.5 cm).
- End-joints of adjacent rows should be staggered a minimum of 4"-6" (10-15 cm) when possible, to ensure a more favorable overall appearance (Figure 4).
- If the Engineered Hardwood Flooring plank is wider than 5" it must be installed applying a 1/4" serpentine bead of premium construction adhesive to the back of each board.

## Installation Guide for Hardwood Flooring

### STEP 4: Installing the Floor (Mechanically Fastened/Staple-Down Installations)

- Always use the correct stapler for the specific product being installed (see “Installation Applications”). Use a minimum 1" (2.5 cm) staple recommended by the stapler manufacturer for 3/8" to 1/2" product and a minimum 1-1/4" fastener for 9/16" products, 1"-2" (2.5-5 cm) from the ends spaced at 3"-4" (8-10 cm) intervals. Continue to Step 5.
- Set compressor at 70 PSI. If tongue damage occurs, lower air pressure (Figure 8).

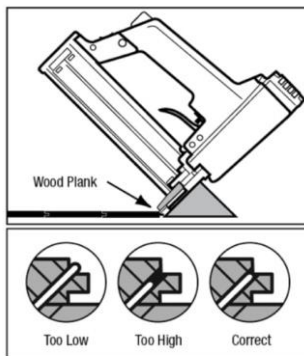

Figure 8

- Fasten several sacrificial boards to the floor. At least two boards, stapled side by side, must be used to indicate proper machine adjustments.
- Check for surface damage, air pressure setting, tongue damage, edge blistering, etc. before proceeding. Make all adjustments and corrections before installation begins. Once proper adjustments have been made, remove, and destroy the boards.
- Install the remainder of the floor working from several cartons.
- The last 1-2 rows will need to be face-nailed when clearance does not permit blind nailing with a stapler or a brad nailer. Pre-drill and face-nail or pneumatically nail on the tongue side, following the nailing pattern used for the first row.

### General Information for Glue-Down Applications

- Maximum adhesive working times:

Adhesive	Working Time
Bruce® Equalizer Pro	45-60 minutes
Bruce ProConnect™ Plus Hardwood Flooring	45 minutes
Bruce® Summit Select	45 minutes

- When not in use, keep the adhesive container tightly closed to prevent thickening. Thickening will cause difficulty in spreading the adhesive.
- Open times and curing times of ALL adhesives vary dependent upon subfloor porosity, air movement, humidity, and room temperature. Urethane adhesive has a shortened working time in high humidity environments, whereas the working time for polymeric resin adhesives will be lengthened. In areas of low humidity, open time will be longer with urethane adhesives and shorter with polymeric resin



## Installation Guide for Hardwood Flooring

adhesives. Adjust the amount of adhesive spread on the subfloor accordingly. The adhesive should not be applied if subfloor or room temperature is below 60°F (16°C). WORKING TIME WILL VARY DEPENDING ON JOB SITE CONDITIONS.

- Hold trowel at a minimum 45° angle (Figure 9) firmly against the subfloor to obtain proper spread rate. The trowel will leave ridges of adhesive and very little adhesive between the ridges. This method will allow you to still see the chalk lines between the ridges and provide the recommended spread rate.

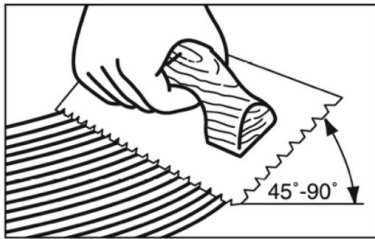

Figure 9

- For additional application instructions, follow the recommendations on the adhesive container.
- Proper ventilation within the room to mitigate fumes. An electric fan is helpful.
- Rolling is not required, but if desired, do not do so until the adhesive has cured for two hours.

**NOTE:** DO NOT INSTALL FLOORING USING RUBBER MALLETS. STRIKING THE SURFACE WITH A RUBBER Mallet MAY “BURN” THE FINISH CAUSING IRREPAIRABLE DAMAGE.

### STEP 3: Spread the Adhesive (Glue-Down Installations)

- Spread sufficient amounts of the recommended adhesive with the recommended trowel (Figure 2) in an area that can be covered in 60 minutes (see adhesive information).
- If necessary, nail a sacrificial row with 1" (2.5 cm) nails on the dry side of your chalk line to help hold the first row in place.

**NOTE:** Avoid installing on the surface of the flooring. If necessary, distribute weight using a kneeler board.

### STEP 4: Installing the Floor (Glue-Down Installations) (Figure 10a-10d)

- Use the longest, straightest boards available for the first two rows. For random and alternate width products, use the widest plank for the first row. The first row of planks should be installed with the edge of the groove lined up on the chalk line. The tongue should be facing the starting wall. The first row must be aligned and seated in the adhesive, as all additional rows will be pushed back to this original row. Remove tongue to allow for expansion space, if necessary, on the row adjoining the wall. Continue to Step 5.

## Installation Guide for Hardwood Flooring

- When installing products wider than 3-1/4" (8 cm), apply a bead of recommended wood glue to all the end grooves prior to installing into the adhesive.
- When installing pieces, engage the end-joint first, as close to the side (long) tongue and groove as possible, then slide together tightly to engage the side (long) joint tongue and groove. To avoid adhesive bleed-through and memory pull-back, avoid, as much as possible, sliding pieces through the adhesive when placing them in position.
- During the installation, occasionally remove a piece of flooring from the subfloor and inspect the back for proper adhesive transfer. Adequate adhesive transfer is necessary to ensure sufficient holding strength.
- If the adhesive skins over and fails to transfer, remove, and spread new adhesive to achieve proper bonding.

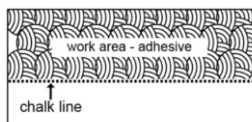

Figure 10a

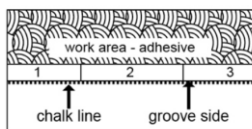

Figure 10b

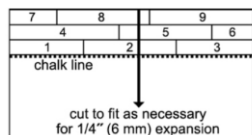

Figure 10c

**NOTE:** Clean adhesive from the surface of the floor frequently, using the recommended adhesive cleaner. Urethane adhesives become extremely difficult to remove when cured. Do not use Scotch® Delicate Surface Painter's Tape 2080 Tape before adhesive is removed from the surface. Use clean towels, changed frequently, to prevent haze and adhesive residue.

- Check for a tight fit between all edges and ends of each plank. End-joints of adjacent rows should be staggered 4"-6" (10-15 cm) when possible, to ensure a more favorable overall appearance (Figure 4).
- It may be necessary to align the product with a cut-off piece of scrap as shown (Figure 11 - Keep scrap angle low to avoid edge damage).

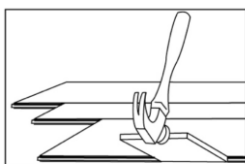

Figure 11

## Installation Guide for Hardwood Flooring

- To eliminate minor shifting or gapping of product during installation, use Scotch® Delicate Surface Painter's Tape 2080 Tape to hold the planks together. After installation is complete, remove all the Scotch Delicate Surface Painter's Tape 2080 from the surface of the newly installed flooring. Do not let the tape remain on the flooring longer than 24 hours. Avoid the use of masking or duct tape, which leaves an adhesive residue and may damage the finish.
- If necessary, use weights to flatten boards with bows until adhesive cures, to prevent hollow spots. Boards that cannot be flattened should be cut in length to reduce the bow or should be not used.
- Be sure not to spread adhesive too far ahead of your work area (Figure 10d).
- Complete the installation using this same technique for the remainder of the floor.
- Avoid heavy foot traffic on the floor for at least 24 hours. Lift the furniture or fixtures back into place after 24 hours.

### General Information for Floating Floors

Floating floors can be installed over any structurally sound surface that meets or exceeds local building codes. Any width of flooring can be installed in this manner, but wider widths are preferred.

- Plan the floor layout (in width) to avoid having to rip the last row narrower than 1" (2.5 cm). This plan may require ripping the first row to assure the last row is at least the minimum width.
- Allow 1/2" (13 mm) expansion around all vertical obstructions.

### STEP 3: Installing the Underlayment (Floating Installations Only)

- Install the underlayment in the same direction the hardwood flooring is to be installed.
- Extend the underlayment a few inches up the wall.
- Trim excess prior to installing trim or moldings.
- The floating floor underlayment may already have double-sided tape for ease of taping the precut overlapping seams (Figure 12). If a non-adhesive underlayment is used, tape all seams with the included tape.

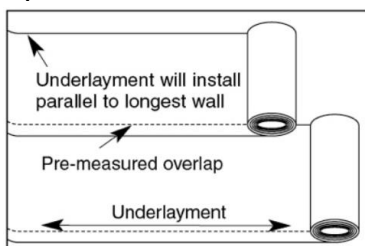

Figure 12

## Installation Guide for Hardwood Flooring

### STEP 4: Installing the Floor (Floating Installations Only)

- The first row can be installed using one of two methods after the layout has been completed (Step 2). Allow 1/2" (13 mm) expansion.
- If the wall is not straight, scribe the first board (Figure 13) as necessary to maintain alignment with the chalk line. Install a sacrificial board (with a straight edge) using the appropriate fasteners for the subfloor. If a board is used for the starter row, make certain the groove faces the wall.

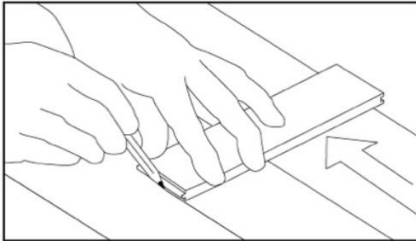

Figure 13

- Align the first row with the wall using wedges to maintain a 1/2" (13 mm) expansion in place and to stabilize the product. If the wall is not straight, scribe the first board (Figure 13) as necessary to maintain alignment with the chalk line.
- Select the first board. All installations should begin with the groove side against the wall using the longest boards available. Apply a continuous 1/8" (3 mm) glue bead to the inside bottom of the groove on the end of the board. Do not apply glue to the groove side at this time (Item C, Figure 14). Products with the end tongue on the left should be installed right to left, opposite tongues should be left to right. (Item D, Figure 14). If a sacrificial board was used, remove it. DO NOT glue the first row to it.

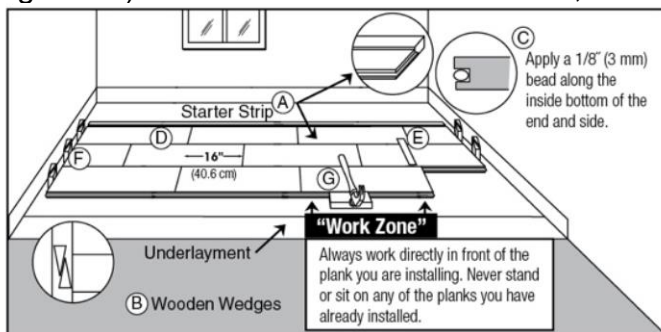

Figure 14

- Complete the first row. Cut the last board allowing for 1/2" (13 mm) clearance between the wall and the floor. (Use the remaining end of the cut board as a starter board for any row following row three). Install a wedge on the end of the board between the hardwood flooring and the wall, allowing 1/2" (13 mm) expansion space. Avoid installation of any boards shorter than 16" (40.6 cm) in the first four rows. (Item F, Figure 14).



---

## Installation Guide for Hardwood Flooring

- Use a pull bar to pull the last board into place from the opposite end. Install wedges into the gap and tighten (Item B, Figure 14).
- If any glue gets on the surface of the flooring, wipe off immediately with a clean damp cloth.
- Cut or use a shorter board for the first board of the second row. Start the second row by applying a 1/8" (3 mm) bead along the inside bottom of the end and side groove of the new board. Install the first board of row two. Apply a bead of glue to the inside bottom of the end and side groove of the next board and install. When installing boards together, use a tapping block against the tongue, not the groove (Item G, Figure 14). Tap the boards into place by tapping with a hammer on the tapping block. DO NOT tap on the edge directly with the hammer. Complete the second through fourth rows using this technique. Insert wedges on the ends, as necessary, to restrain the movement of the floor.
- In the remaining rows, stagger joints 4"-6" (10-15 cm) apart. Install the rest of the floor. Be sure all joints are tight. Use spacers on the long end and butt walls. Use a tapping bar to tighten the joints from the ends.

### **STEP 5: Complete the Installation (All Installation Methods)**

- Remove all tape and clean the floor with the recommended hardwood flooring cleaner.
- Trim all underlayment (floating only) and install or re-install any transition pieces, reducer strips, T-moldings, thresholds, bases and/or quarter round moldings that may be needed. These products are available pre-finished to blend with your flooring (see below). Nail moldings into the wall, not the floor.
- Inspect the floor, filling all minor gaps with the appropriate blended filler.
- If the floor is to be covered, use a breathable material such as cardboard. Do not cover with plastic.
- Installers: Leave warranty and floor care information with the owner. Advise them of the product name and code number of the flooring they purchased.
- To prevent surface damage, avoid rolling heavy furniture and appliances on the floor. Use plywood, hardboard, or appliance lifts if necessary. Use protective casters/caster cups or felt pads on the legs of furniture to prevent damage to the flooring.

---

Installation Guide for Hardwood Flooring

**TRANSITION AND WALL MOLDINGS**

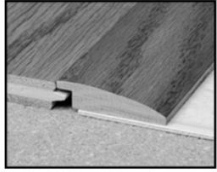

Reducer Strip

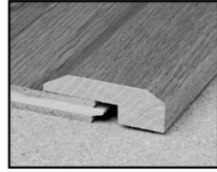

Threshold



Stair Nosing



Quarter Round

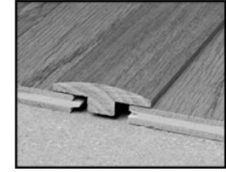

T-Molding

- **Reducer Strip:** A teardrop shaped molding used around fireplaces, doorways, as a room divider, or as a transition between hardwood flooring and adjacent thinner floor coverings. Fasten down with adhesive, small nails or double-faced tape.
- **Threshold:** A molding undercut for use against sliding door tracks, fireplaces, carpet, ceramic tile, or existing thresholds to allow for expansion space and to provide a smooth transition in height difference. Fasten to subfloor with adhesive and/or nails through the heel. Pre-drill nail holes to prevent splitting.
- **Stair Nosing:** A molding undercut for use as a stair landings trim, elevated floor perimeters, and stair steps. Fasten down firmly with adhesive and nails or screws. Pre-drill nail holes to prevent splitting.
- **Quarter Round:** A molding used to cover expansion space next to baseboards, case goods, and stair steps. Pre-drill and nail to the vertical surface, not into the floor.
- **Combination Base and Shoe:** A molding used when a base is desired. Used to cover expansion space between the floor and the wall. Pre-drill and nail into the wall, not the floor.
- **T-Molding:** A molding used as a transition piece from one rigid flooring to another of similar height or to gain expansion spaces. Fasten at the heel in the center of the molding. Additional rigid support may need to be added to the heel of the molding dependent upon the thickness of the goods covered. Do not use this molding as a transition to carpet.

## Installation Guide for Hardwood Flooring

### CARE: INSTALLERS – ADVISE YOUR CUSTOMER OF THE FOLLOWING

#### Seasons: Heating and Non-heating

Recognizing that hardwood floor dimensions will be slightly affected by varying levels of humidity within the structure, care should be taken to control humidity levels and maintain them in the 30-50% range. To protect the flooring and provide lasting satisfaction, the manufacturer's recommendations are below.

- Heating Season (Dry): A humidifier is recommended to prevent excessive shrinkage in hardwood floors due to low humidity levels. Wood stoves and electric heat tend to create very dry conditions.
- Non-Heating Season (Humid, Wet): Proper humidity levels can be maintained by use of an air conditioner, dehumidifier, or by turning on your heating system periodically during the summer months. Avoid excessive exposure to water from tracking during periods of inclement weather. Do not obstruct in any way the expansion joint around the perimeter of your floor.
- Damage caused by failing to maintain the proper humidity levels is not manufacturing related and will void the floor's warranty.

**NOTE:** Final inspection by the end-user should occur from a standing position.

### FLOOR REPAIR

Minor damage can be repaired with a Bruce® touch-up kit or similar product. Major damage will require board replacement, which can be done by a professional floor installer. Instructions for the board replacement can be found at [ahfproducts.com](http://ahfproducts.com).